

Product Code: J SFSNK EF C-ST-WHT

Revision: D2

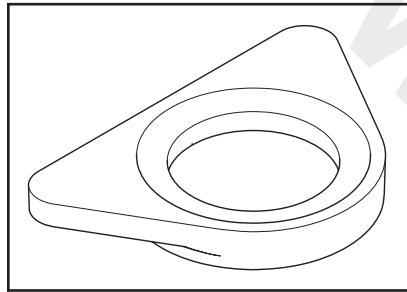

1

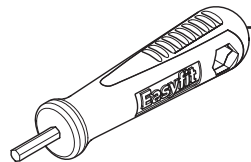

2

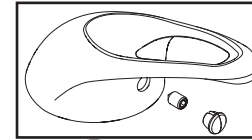

3

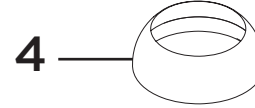

4

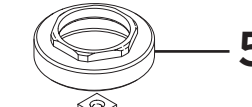

5

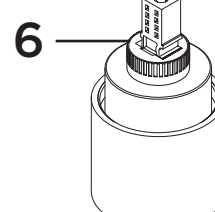

6

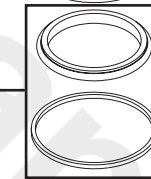

7



8

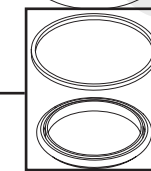

9

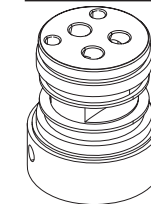

1	Reinforcing Plate
2	EasyFit Tool
3	Handle Assembly
4	Shroud
5	Cartridge Retaining Nut
6	35mm Ceramic Cartridge
7	Spout Seals Kit
8	M5 x 10mm Grub Screw
9	Anti-Splash Assembly
10	EasyFit Pack
11	Isolation Valves (Pair)
12	Molykote Grease
13	1/2" BSP Flexible Tails (Pair)

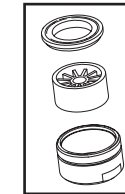
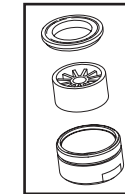
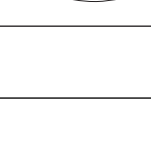

Product Code: J SFSNK EF C-ST-WHT

Revision: D2

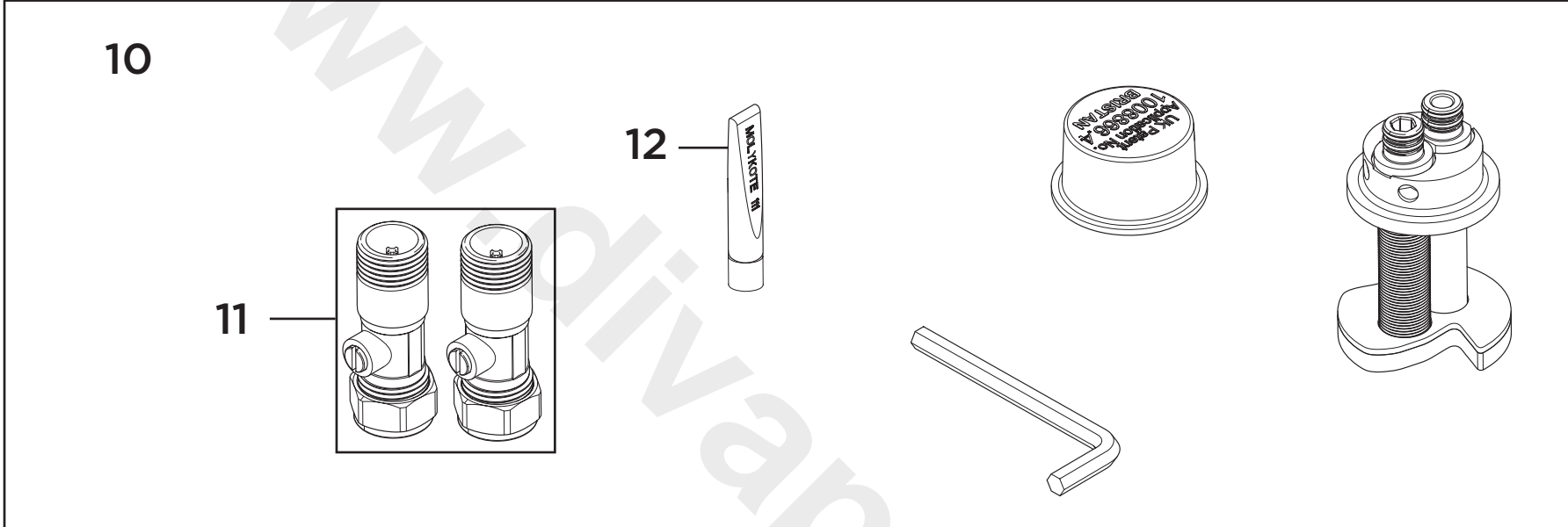

1	Reinforcing Plate
2	EasyFit Tool
3	Handle Assembly
4	Shroud
5	Cartridge Retaining Nut
6	35mm Ceramic Cartridge
7	Spout Seals Kit
8	M5 x 10mm Grub Screw
9	Anti-Splash Assembly
10	EasyFit Pack
11	Isolation Valves (Pair)
12	Molykote Grease
13	1/2" BSP Flexible Tails (Pair)

